

VACLIFE

TIRE INFLATOR

USER MANUAL

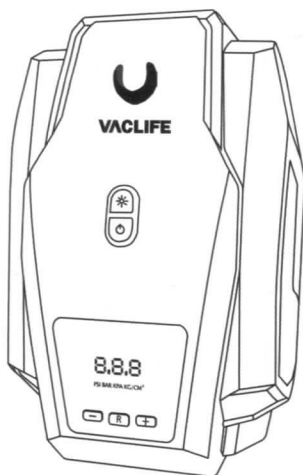

// VL701

THANK YOU FOR YOUR PREFERENCE FOR VACLIFE

If you have any problems with our product, please feel free to contact us.

✉ support@vaclife.com

// CAUTIONS

Note: Please read carefully and **SAVE THESE INSTRUCTIONS FOR FUTURE REFERENCE**. Misuse may lead to product damage and physical injury.

ⓘ Precautions

- Do not disassemble, repair, or modify the appliance by yourself.
- Keep the appliance out of the reach of children and pets. Close supervision is necessary when the appliance is used around children.
- Keep the appliance away from fire, flammable gases, liquids, and strong magnetic fields. Or it may increase the risk of fire and burst.
- This product contains small accessories which might cause suffocation of children.
- The appliance is applicable to cars with tire pressure ≤ 50 psi and tire width ≤ 245 mm. It's not suitable for large vehicles like trucks, vans, or off road vehicles.

ⓘ Safety Instructions

- Do not use this appliance in the rain, snow, or where there are liquids.
- Do not use the appliance if it is damaged or the cable is broken, it might cause electric shock.
- Check if the nozzle and preset pressure are suitable for the inflatable before inflation, or it may impose hazard.
- Use the accessories included in the package ONLY.
- It is normal that the air hose and the cigarette lighter may get hot during and after use. Avoid long-time physical contact with these parts.
- It is recommended that the continuous working time of this appliance should be less than 10 minutes. Let it cool down for 10 minutes between every 10-minute use.
- Please do not over-inflate, or personal injury might be triggered due to high pressure.
- Please do not pull the cable or the hose violently.
- Experiments show that the gas of the car tire will escape when the air nozzle has been removed, leading to a decrease of 0.5-2.0 PSI in tire pressure. Vaclife considers this case, so we make a unique design that the tire pressure would exceed 0.5-2.0 PSI over the preset pressure. This allows it to achieve proper tire pressure after the removal of the air nozzle.

ⓘ Storage and Cleaning

- Let it cool down before storage.
- Please keep the appliance in a dry and cool place when not used for a long time.
- Do not use chemical detergent to clean the appliance. Use mild soap and a damp cloth to wipe the body only.



// PRODUCT DETAILS

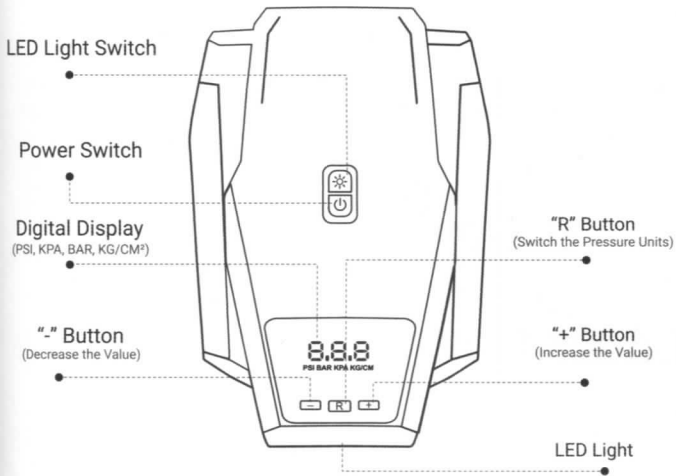

// PRODUCT PARAMETERS

Power: 120W

Working Voltage: DC 12V

Maximum Operating Current: 10A

Maximum Working Pressure: For Tire Pressure ≤ 50 PSI

Pressure Measurement Accuracy: ± 0.5 PSI

Pressure Unit: PSI, KPA, BAR, KG/CM²

Continuous Working Time: ≤ 10 Mins

Material: ABS + Metal

// DISPOSAL INFORMATION



• This appliance is made of environment-friendly and recyclable material. Recycle where possible.



• Do not dispose of the appliance in the normal domestic waste! Dispose of the appliance and accessories in accordance with local regulations.



// PRODUCT OPERATION

HOW TO USE

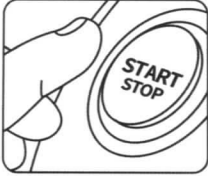

Step 1
Start the car engine.

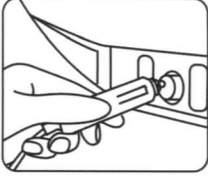

Step 2
Insert the power cord into the 12V cigarette lighter socket.



Step 3
Remove the dust cap of the valve, and then connect the air hose to the valve. Make sure the hose and valve of the inflatable are connected tightly.



Step 4
Check the current pressure of the inflatable first. Then, press the "R" button to choose the pressure unit, and then press "+" or "-" to set your desired pressure. When the number stops flashing, the pressure is set.

-4-

// PRODUCT OPERATION

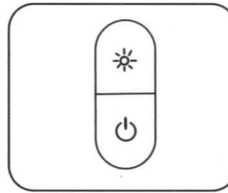

Step 5
Press the power switch to start inflating. When the preset pressure is reached, the inflator will automatically stop.

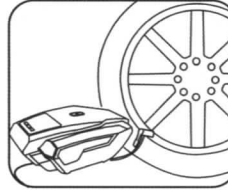

Step 6
Press the power switch again to turn off the appliance after inflation. Disconnect the power cord and the nozzle.

LIGHTING FUNCTION

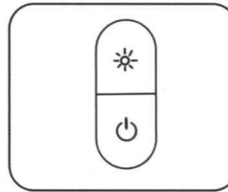

Press the LED light switch to turn on/off the light when using the appliance at night or in dark environments.



-5-

// TROUBLESHOOTING

// WARRANTY

Problems	Possible Reasons and Solutions
The inflator does not work.	<ul style="list-style-type: none">• Check if the preset pressure is lower than the current pressure.• Check if the power cord is connected tightly.• Check if the car engine has been started.• Check if the glass fuse is damaged.
The inflation is slow.	<ul style="list-style-type: none">• Check if the air hose and the inflatable are connected tightly.• Check if the air hose leaks.
There is air leakage.	<ul style="list-style-type: none">• Check if the inflatable leaks.• Check if all connecting parts are connected tightly and ensure the nozzle is screwed tightly.
The appliance works normally, but the current pressure shows 0.	<ul style="list-style-type: none">• Check if the hose is damaged.• Low-pressure inflatables like balloons are not measurable by this appliance.• When the tire is flat, it takes a little time for the tire pressure to be measurable.
Accessories are missing or damaged.	<ul style="list-style-type: none">• Please contact our customer service team.

If you have any other problems, please feel free to contact our customer service team.

 support@vaclife.com

ABOUT WARRANTY

Q: Do you have a warranty for this product?

A: We strictly abide by the Amazon regulations which cover a full refund or a free replacement within 30 days after your purchase. Additionally, we offer a 2-year warranty, if there are any problems with this product, please always feel free to contact us at support@vaclife.com. We promise our team always stands behind our product and we will try our best to offer you a better user experience.

// QUICK START GUIDE

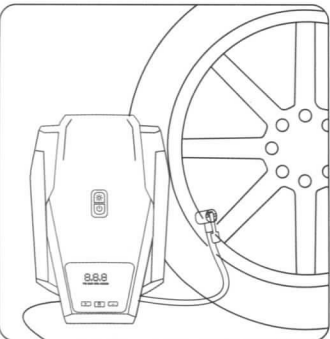

The maximum working time should not be over **10 minutes** for a single use.

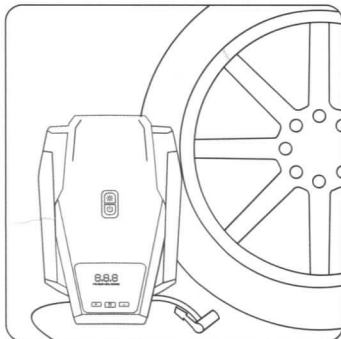

There should be an interval of **10 minutes** between every two uses.



The pressure level on the display will **keep flickering** when you preset the desired pressure.



Start inflating after the **flicker stops**.

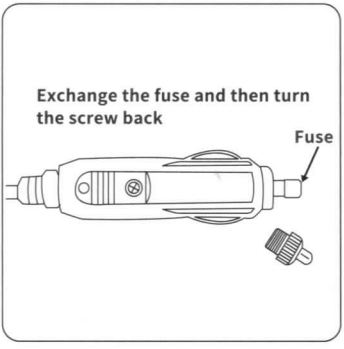
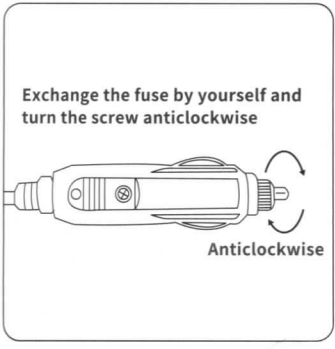

Please check the status of the fuse if your appliance fails to start.

Follow instructions listed to change the defective fuse to get the appliance back to work.



A 2-year warranty is available for this product. Please contact us to get help if you have any problems with it.

/CONTACT US/

✉ E-MAIL:

support@vaclife.com

